

Making Your Own Colloidal Silver Generator

by Ken Welch

KEN-WELCH.COM

Inside an earlier incarnation of Ken-Welch.Com we had three separate web pages devoted to colloidal silver. Readers were interested in anything that might help them survive a deliberate release of the recently recreated 1918 pandemic influenza, currently being shopped around as “Bird Flu.” CS seems a likely remedy in that event. So I put together a report detailing how I had made my own CS generator for Y2K. Since I was still using it, there was no problem describing it in detail and taking photos that showed its construction and use. This was soon followed by another report on how the design could be easily improved, and some commentary on the conflicting information about colloidal silver to be found on the web. Finally a third report was added for those who simply wished to purchase a CS generator that wouldn’t cost too much, but would clearly do the job.

All that information has now been gathered up and merged together in this report which you can simply download and read at your leisure. And feel free to pass on to others. Colloidal silver has been called an antibiotic “super hero” and many people are surprised to learn just how easily you can produce your own. In the event of a true pandemic, commercial CS generators will disappear quickly. If you haven’t already bought or built your own, then this report by itself might be a lifesaver.

Please note that where parts of the original material need clarification or update I have simply inserted notes in blue type with newer information.

Emergency Colloidal Silver Generator Ugly - But It Works

I put this colloidal silver generator together in 1998 to be part of my Y2K emergency supplies. I wanted something that would cost almost nothing to make (except for the silver), and take virtually no room in a backpack or bug-out bag. Most generators use silver wire. I chose these flat 1-ounce silver bars because they were instantly available at a local coin store, and they contain enough silver to make C.S. for several lifetimes. Of course, in 1998 they only cost about seven dollars each! You would certainly pay a lot more today, but in a panic situation this could still be the only form of .999 pure silver you could quickly get your hands on.



In this photo I am about to make a batch of C.S., and you can see everything I will be using. Obviously, the C.S. generator is incredibly simple.

This is a good design to study because it includes the essentials and nothing else. You will have a full understanding of what is necessary and then, if you are inventive, you can easily design your own much fancier system if you wish. Or just bite the bullet and purchase one, of course.

A colloidal solution (or suspension) is simply a liquid containing particles so small that they remain suspended indefinitely. Milk is an example of a colloidal solution. Wherever the liquid goes, the particles go.

A colloidal silver generator operates on the same principle used in electroplating, which is the process of placing a very thin coating of one metal onto another. Two pieces of metal

are placed in a solution and an electrical current is passed between them. As electrons leave the donor metal they take with them tiny particles of that metal, and carry them through the solution to be deposited on the object being plated. Many of these particles get “lost” in the liquid. They are so small they remain suspended in the liquid, rather than settling to the bottom of the container. If silver is the donor metal, you have made a colloidal silver solution which can be used to kill many harmful microorganisms on contact, especially in the gut. This is not IONIC silver, which is used to build up resistance to infection throughout the entire body.

There is one skill that you must master: making a good connection so that electrical current can flow from one metal part to another part. Basically, you must have firm metal-to-metal contact, and some means of maintaining that contact. Being slightly older than the average bear I used solder, a soft metal alloy that melts and joins two metals together when all are heated with a soldering iron. Been doing it since I was a kid! There are some fairly simple alternatives, but I’m sorry to say that glue is not one of them! I’ll go over some of these other methods in the discussion below.

FIRST, I’ll show you how to assemble the generator. NEXT, you will see this amazing device in action.

Here are the items you saw in the picture:

three or four snaps-and-wires connectors for nine-volt batteries (Radio Shack)
two flat silver ingots clearly marked “.999 fine.” (Coin shop)
two pieces of insulated electrical wire, each about a foot long (junk box/Auto Zone)
(wire should be stiff enough to be bent into a shape and stay that way)
three nine-volt batteries
A glass container with a wide mouth and a stick—in this case a cheap ball-point pen
Distilled water.

Notes:

You can easily get by with just two batteries and two connectors. I simply wanted a little extra voltage. When operating, I usually take one battery out of the circuit after five minutes or so. More about that later.

Technically, you can get by with a single piece of silver—as if you were plating silver onto any piece of conductive metal. If you get the direction of the current flow wrong, however, you end up making colloidal “something else” which you certainly would not want to drink. Two pieces of silver keep the design fool-proof. With a hacksaw you could cut one of these silver bars lengthwise and end up with two narrow strips that would work just fine. Might only last for 40 or 50 years, though.

(Don’t rush out and buy those connectors until you’ve read the whole report. I found out recently that there is a better alternative.)



Here are the three 9-volt connectors. A little plastic hat holds the two snaps that mate with each battery. From the end comes a red and a black wire about four inches long.

I got mine from Radio Shack, a store that supports electronics hobbyists. These connectors are dirt cheap, but of course Radio Shack doesn't think so. Mine came in a package of four, and there is a use for the fourth one when removing a battery from the circuit.

Here is an assembly diagram that shows the connections that must be made. In my case, I twisted the ends of wires together and soldered them. I also covered the connections with heat-shrink tubing (Radio Shack again). You could use electrical tape or virtually any form of plastic tape, but they should be protected in this way.

A good option for joining the very thin wire from the battery connector to the larger stiff wire is the screw on caps found at many hardware stores for this purpose. Just twist the wires together tightly, insert them into the opening in the cap, and screw the cap down tight. This will probably take the smallest cap that is offered.

In an emergency, just twist the bare wires together and keep them physically separated from other wires while you make one batch.

Remember, the third battery (and connector) is optional. You can get by just fine with two.

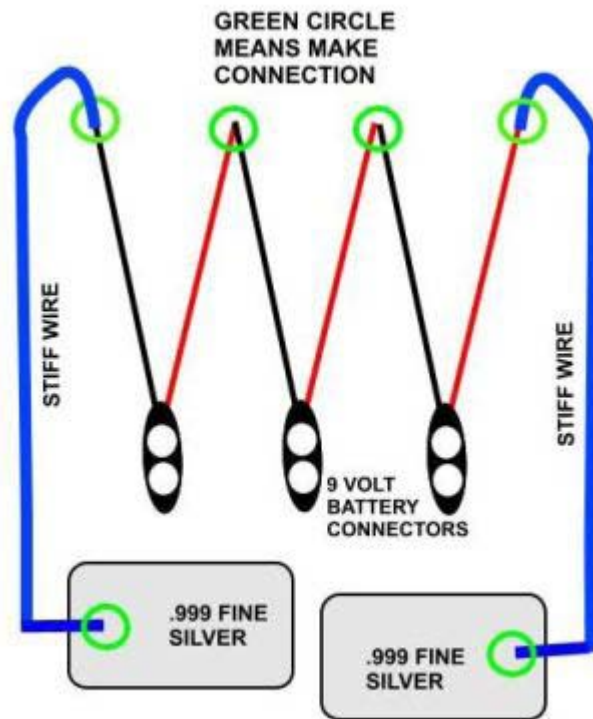

You must strip about half an inch of the plastic insulation from the ends of the "stiff wire" to work with the bare metal strands for joining to the battery wires and to the silver. If this is an unfamiliar concept, then I strongly suggest that you ask among your friends and see if someone you know is more comfortable with this type of project. Remember, you can promise them all the colloidal silver solution they might want!



About the silver:

Remember this was an exercise. I chose the silver bars because they were cheap and immediately available at a nearby coin shop. No waiting for the postman a week later. In a pandemic, delivery services are likely to be disrupted as drivers call in sick. Silver wire or rods are much more convenient, and they now come with even greater purity: .9999.

Naturally, you want your silver to be as pure as possible. You must not use "sterling" silver, because that alloy includes other metals to make it softer and more workable for jewelry making.

I don't know of any source for absolutely pure silver, which would be extremely expensive anyway. Instead, silver which is assayed to be 99.9% pure (.999 Fine) is what everyone uses, and it works just fine.

You can buy .999 silver wire from various sources on the web. However, this is the same purity as used in the "precious metal" business, and I used two one-ounce silver bars as I mentioned above. Whatever your choice, you must have that high purity that is guaranteed when you see the phrase ".999 FINE" stamped into the metal.

I don't recommend that you try soldering to the silver bars like I did. It was almost impossible to get them hot enough. I ended up placing them on a fire-proof brick, and used a small hand torch to get one corner hot enough for the solder. You would not enjoy this. It works (as you can see) but it's neither fun nor pretty.



Instead, for a permanent connection I suggest you simply pick up a pair of small machine screws at the hardware store, with matching nuts. Drill a hole in the silver bar, bend your wire around the screw and tighten it down, trapping the wire between the screw head and the silver.

An even better alternative is available at Radio Shack. Replace the stiff wire with "jumper wires." These have alligator clips already attached to each end. The alligator clip can clamp onto the silver and make the electrical connection. You will probably want to cut off the clip on the other end and use the twist-together method for attaching it to the battery wire.

You could also use a spring steel binding clip, like those sold at office supply stores, to clamp the wire to the face of the silver bar near one edge (you'll need three hands). In an emergency you could even try rubber bands to squeeze the bare wire against one edge. Even tape might hold the connection together long enough to make a single batch as long as you keep the tape out of the water.

Essentially, all you need is something that will squeeze bare metal wire up against the silver, and keep on squeezing for 20-30 minutes, while also holding the weight of the suspended silver pieces. Remember, when working with wire and trying to get that good metal-to-metal connection, the metal must be clean and bright. Scrape the wire with a knife blade or other metal tool to get that shiny appearance.

ASSEMBLING FOR USE

Now don't laugh at how clumsy this looks. Remember it was designed for emergency use, and to be created in a hurry. The only requirement here is that the silver has to be suspended in some way so that half to three quarters of it is immersed in the water and the corners with solder or screws are above the water. In this case, we simply use a single turn of the stiff wire to hang each silver bar from a ball point pen. At this point the jar is empty:

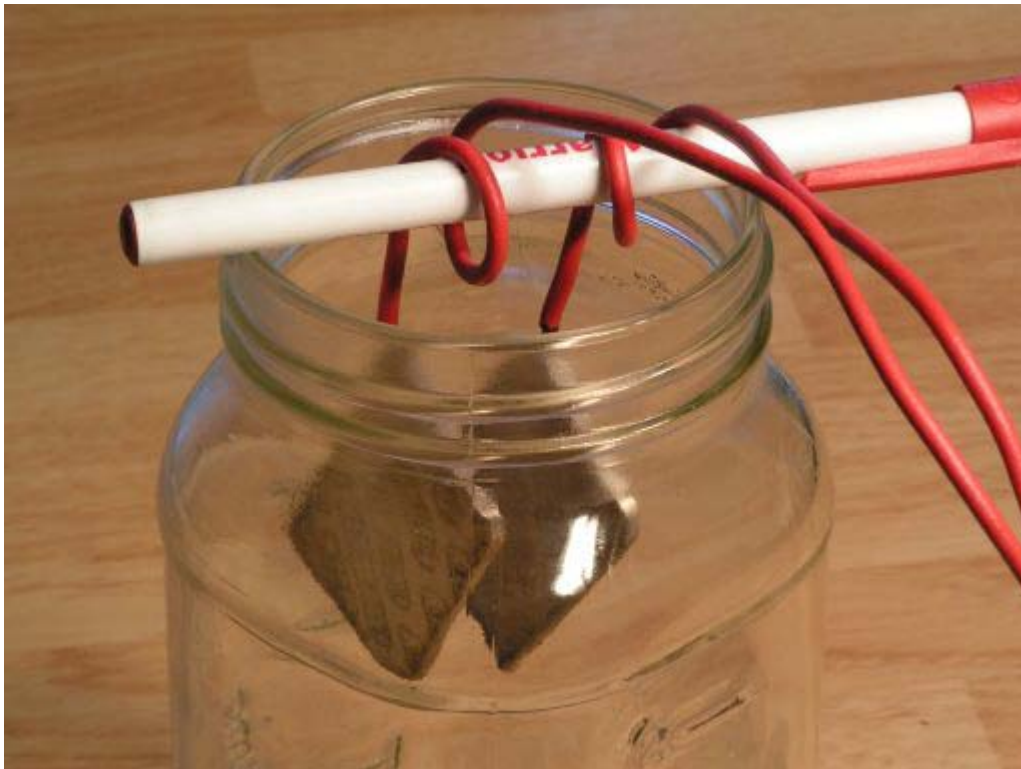

You will probably spend a few minutes fiddling with the wire to get the two silver bars to hang straight, with the flat sides facing each other. It doesn't have to be perfect, but it should look like this:



After you have the silver bars positioned in the jar you connect the batteries to the connectors. This may disturb your arrangement and you will get to readjust it a bit. The wires are long enough that the batteries simply rest on the table top. There should be no pulling on the wires from their weight.

This business of hanging loosely from a stick is probably the first thing you will want to improve, unless you like being able to roll up the silver and the wiring harness and put it in a pocket or an envelope like I did. You might, for instance, tape or glue the two wire loops in place so you don't have to position them each time. You could pass the two wires through holes in something flat, like a short piece of a plastic ruler, and thus have them automatically positioned for you. In fact, you could then mount your batteries right on this flat surface and avoid long lengths of wire.

Making a Batch of Colloidal Silver Solution

Now that the silver bars are neatly positioned, and the batteries are hooked up to the connectors, the next step is to add water. I always use distilled water because I don't want any other chemicals, minerals or metals adding unknown factors to the end result. In an emergency, you would simply use the cleanest water you could find, including tap water. In the woods, germs would be killed by the C.S., but I rather doubt it is any good against parasites. So boiled water would be the way to go.

Pour the water in slowly so you don't disturb the positioning of the silver bars. Allow the level to come about three quarters of the way up the sides of the silver. The important thing is not to allow the water to get near the connecting points. If the connectors are in the water, then you will have metal from the wires, the solder, or the hardware being zapped into the water along with the silver. That could create a colloidal metals mixture that could get nasty! So keep the hardware out of the water!

Reflections and natural distortion make the details a bit hard to see in this photo, but the soldered area on these silver bars is above the water line.

With the batteries already connected, the generator begins working as soon as you add water. But your first impression will be that nothing is happening. This is almost true. Pure distilled water does not conduct electricity very well. You might see some small bubbles forming and that's about it. It's a good time to take a long break.



In the photos that follow, I have put a very small amount of salt in the water to increase its conductivity and make the action more visible. Salt is sodium chloride. The silver will react with the salt and you get silver chloride, which is the visible white smoke. Actual colloidal silver in pure water is NOT visible, so without a small amount of salt the photos wouldn't show you much.

The import thing to remember about silver chloride is that it is worthless. It does not kill germs, so creating it is just a waste of silver. In an emergency you can use a few grains of salt to create a temporary "starter" solution, then start over with fresh distilled water and perhaps a couple tablespoons of the starter. In pure distilled water you could also just let the device run for two or three hours.

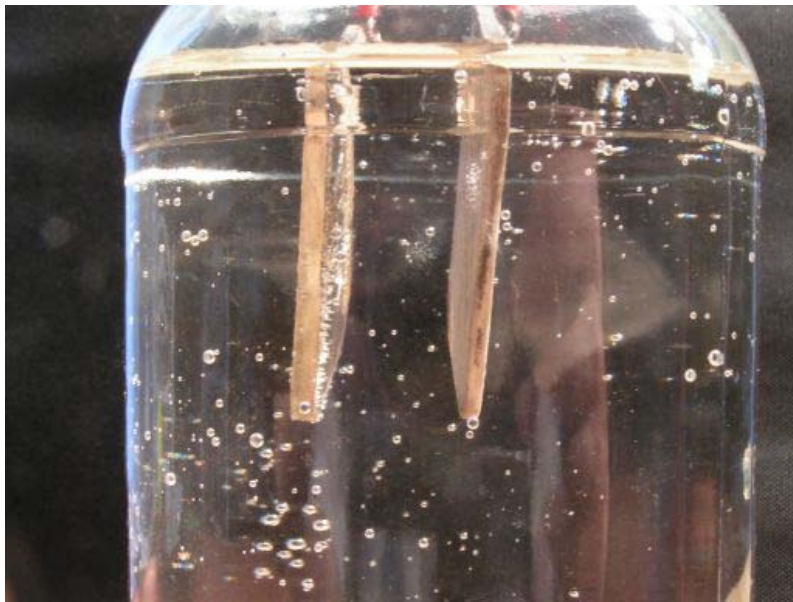

Eventually you will see a tiny wisp of white “smoke” beginning to drift downward from a corner of one of the silver bars. Small bubbles will also form on that bar. This is the bar that will be sending silver particles through the water.

The bubbles contain oxygen, and are responsible for the “soot” of black silver oxide that needs to be wiped off from time to time - or it will fall into the water and make it look dark grey and generally unappealing.

As conductivity builds up in the water, the full 27 volts starts blasting silver into the solution. As you can see, most of it is not making it over to the other electrode.



When I chose three batteries for my generator, totaling 27 volts, it was because I wanted the process to start quickly. Once it is up to speed, though, I prefer to cut back to just two, which reduces the power to 18 volts. This is easy because there were four 9-volt connectors in the package I bought. Take the fourth one and twist the ends of the wires together to create a short circuit between the two snaps.

Simply remove one of the batteries from its snap-on connector, and then press this fourth connector into the snaps it was using. You now have an 18 volt circuit that works fine.

So how much is enough? How long should you let the process continue?

To gauge your progress, watch the color of the water. If everything was pure and you were using very low current, you wouldn't see anything at all. But there are usually enough impurities in the water and silver, as well as a silver oxide byproduct (from high current), that your solution will take on a slightly grey color, and it is no longer fully transparent. Seven or eight years ago this is where everyone stopped. I've been told this corresponds to about five parts of silver per million parts of water, or 5ppm. Personally I think it is a bit more than that.

To be honest, I've never known this strength not to work as an efficient germ-killer, and this is generally the strength that I would use for food poisoning, as an example, when I want to drink a third of a cup in one shot.

Competition between commercial producers has sparked a drive for higher concentrations. You achieve this by simply letting the process continue to run, and you will see the water turning darker and the grey may even get a brown tint. It can look pretty murky, and may need to sit quite a while to become clear. Commercial labs have treatments and filtering that provide a better appearance, and there is a trick to getting that gold color that some brag about. All that really isn't necessary for personal use. The solution is perfectly drinkable without filtering. Especially in an emergency.

I don't normally go for high concentrations of silver and usually stop the process when it reaches the grey color you see below. First, disconnect one of the batteries. That breaks the circuit and no more current will flow. Remove the silver elements and this is what you have:

Clean the silver right away

As you can see in this photo, the silver elements are now badly discolored. The black material seems to be silver oxide. If this were iron we would call it rust. Since it's silver, we call it tarnish. At this point, though, it is not bonded to the surface and most of it will scrub right off with a stiff brush under running water. I use a non-scratching scouring powder (Bon Ami, or Bar Keepers Friend) to gently remove the remainder. Actually, it doesn't matter if you scratch the silver —you've got plenty. But you want to do this right away because the longer you wait the more difficult it will be to scrub away.

On the other silver bar you can see a brown color, and I suspect this is that one part in a thousand that is not silver. It will come off easily as well.



Some of that black silver tarnish is also in the water, creating the grey appearance. Eventually it will sink to the bottom and may even bond slightly with the glass itself. It is not harmful, but if you were producing C.S. commercially you would be wanting to filter it out simply to improve the appearance of your product.

You should also clean the silver at this point if you want to continue the process and make your solution even stronger. A coating on the silver elements might reduce efficiency, and any of it that ends up in the water is just going to make it look bad.

Here's the finished product, and a typical dose ready to deliver fast germ-killing action to the stomach, intestinal tract, kidneys and bladder.



I continue to learn about colloidal silver, and recently found out that a very tiny amount of pure vitamin C crystals can be added at this point, and silver ions—too small to be colloids—will clump together and become colloids. I'm still not clear about the benefit of this, but it adds a rather wonderful opalescent look to the solution when you hold the jar in a bright light.

Colloidal silver solution will remain good for a long time if kept away from light. Commercial preparations come in dark bottles, but I find that keeping it in a bottle inside a kitchen cupboard that is normally closed will do just fine. Nonetheless, I have an impression that freshly made solution is more potent. This may be entirely psychological. Still, if my CS is three or four months old, I usually find myself making up a fresh batch if the need for a strong, antibiotic punch arises.

Remember if you take much colloidal silver at all, you **MUST** replace beneficial bacteria in your intestinal tract that you destroyed. I was not able to stop a home-made yogurt culture with colloidal silver. That's good. However there are other beneficial probiotics besides acidophilus, and you could easily be killing some of those. Eat freshly home-made yogurt (supermarket brands are not reliable) or take "probiotics" capsules, several hours after taking C.S. If you don't do this you can quickly lose vitality and your overall immune system will be diminished, just as if you'd taken penicillin or any other antibiotic.

Designing Your Own Colloidal Silver Generator

The colloidal silver generator presented in this report is easy to make, and clearly demonstrates the basic principle involved. If you are at all inventive and also familiar with basic electricity, you may be thinking already about how to improve the design.

If you are just going to use it at home you'd probably like to dispense with the batteries and plug it into an electrical outlet. One of those small power supplies that come with so many electronic products today immediately comes to mind. However, you'll need an appropriate voltage and you have no idea how much current it must handle once the process is really going strong. So I recommend that you not try this, and instead look at the small "economy" unit from Elixsilver shown in the last section of this report.

The most obvious consideration is that if you can make one these ahead of time, then you don't need the "emergency" silver bars! They are serious overkill. You can simply google for .9999 silver wire (or rods), the same component used in virtually all the commercial offerings, and create something that is immediately more elegant (and two ounces lighter).

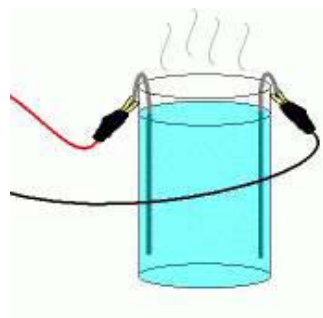

Do you remember the "jumper wires" I mentioned, with alligator clips on each end? They would sure make it easy to connect to your silver pieces, whatever style you end up with. Now we are really getting portable.

Now this is embarrassing. Years later, I finally learned that you don't need those 9 volt connector wires at all! That's right. 9-volt batteries will snap to each other in an idiot-proof way and no adapters or connectors are required. Just attach your two alligator clips to the two snaps that remain unused. I felt dumb as a fencepost when I saw someone do this!

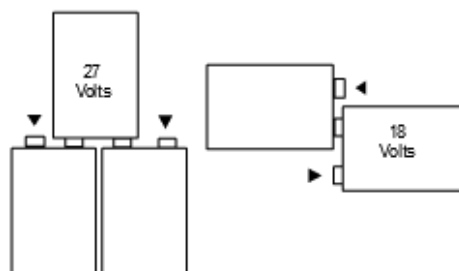

There are many more things that would be nice to have, but you simply won't be able to add them as cheaply as a manufacturer can. So you'll go to a commercial unit for extra convenience and specific features you'd like to have. I've looked around the web and found some good candidates. They're listed below. I wasn't interested in anything over a \$100, although I included one item over my limit simply because it was unique and interesting. They're all interesting and you may see something that you would be happy to purchase, rather than build a basic unit on your own.

Ionic Silver vs. Colloidal Silver

As soon as you go to the web you will be deluged with information about colloidal silver (and ionic silver) that includes a lot of disagreement between the various sites. There is even deception there, because there is intense competition between sellers. And don't forget that for many the idea that you might want to build your own CS unit simply means a lost sale.

The greatest confusion involves Colloidal silver vs. Ionic silver. Ionic silver is also sometimes called Nano silver, or Angstrom silver. They are actually very different animals. Ionic or Nano silver particles are supposedly able to penetrate body tissues and even enter the cells. Theoretically this is the form you would choose to build up resistance to infection throughout the body, IF these tiniest of particles can make it through stomach acids, saline body fluids, filtering by the liver, etc.

It is also known that it is the electrical charge held by individual silver ions that actually kills harmful bacteria, etc. But this happens even when the ions are clumped together as a colloid.

An ion is much smaller than a colloid, and has different characteristics. You can put trillions of ions in a glass of water and it will remain perfectly clear. Ionic minerals (which normally only come from plants) can be absorbed right into the body's individual cells. It is said that ionic silver easily enters the bloodstream where it can circulate and do good things for up to two hours before the liver filters it all out again.

This suggests that it is actually the ionic (smaller) form of silver that might produce the Holy Grail of CS: allowing you to build up some silver in the body tissues themselves as (we assume) protection against future infections. This is much more like taking a nutritional supplement than an antibiotic. But until recently, no one ever suggested that people might have a silver deficiency. Now there are some hints that this might be so. Most of us are deficient in just about everything, so why not silver?

Although positive testimonials about the good effects of Ionic Silver are increasing, there are still some aspects that I personally find confusing. Many body fluids are saline. Will that neutralize the silver? How about stomach acid? Should I.S. be taken on an empty stomach? On the other hand, there are a number of health problems where a lurking, unknown microorganism might be the cause. So I'm hopeful that we will soon see testimonials about mystery problems going away without any need to ever identify the villain.

Happily enough, the classic colloidal silver generator produces plenty of silver ions, especially at lower voltages. So those that don't clump together with others to form colloids are still in the mix. The amounts produced depend on the amount of electrical current flowing through the water. Higher currents, I've been told, tend to blast off larger particles from the silver donor element, including particles that are a bit too large to be true colloids and eventually sink to the bottom of the glass. Low current tends to generate smaller particles, and therefore more ions. And there seems to be less silver oxide soot produced.

This is one of the reasons I like to take that third battery out of the circuit once my own C.S. unit begins putting out that "smoke" from the donor silver bar. This brings the current down. In fact, I may even do the same for the second battery in the future. However my primary use for C.S. is getting rid of bad stuff in the gut, and we've already learned we can do that quickly and easily with the classic colloidal silver we've been producing at home for years.

Would a solution containing only ionic silver be able to blast its way down through the gut and kill off influenza, salmonella or E-Coli as quickly and forcefully as quick-and-dirty colloidal silver solution does now? I simply don't know. I'm not sure if anyone else knows either. So for the time being I'll stick with the tried and true, and use regular colloidal silver for this type of emergency. Perhaps I will pick up one of these ionic silver generators when I want to experiment with enhancing my immune status in general.

The basic problem with Ionic or Nano silver units is that they compete, and advertise, via the technical features of their machines. But do any of those features have an actual health benefit? I'm not sure how you would measure or prove such a thing.

Do it yourself units, and the less expensive units on the web are all old school colloidal silver makers. Experience has taught that they are perfectly good for certain tasks:

- 1) killing off bad bugs in the stomach, intestines, kidneys, bladder, etc.
- 2) topical applications for wounds and open infections - must be wet
- 3) infection-fighting nose drops, even eye drops
- 4) protecting stored water, and more.

Of particular interest in current times is the fact that influenza viruses, even though they cause effects in the respiratory system, actually live and multiply in the gut. This has been known for a hundred years, but I guarantee it's not something your doctor will tell you. So my personal choice in a "some kind of flu" pandemic, which we've been promised for over a decade, would be a quarter cup of standard colloidal silver every day (maybe even twice a day) until the danger has passed.

Commercial Units

From our original web pages, these were the more interesting units I looked at in... 2006? Sorry to say many of them are long gone - and replaced by more expensive units now. However the first one, which I eventually bought for myself, is still around and works great. Costs have increased, of course, but money is worth less now than it was then.

I will probably create a review page on Ken-Welch.Com for all the current offerings that look worthwhile. Many readers are interested in such things, even more as media ramp up the impression that killer germs are on the loose, and can appear at any time.

OK, let's look at some commercial offerings. My target price is \$99 or less, although I might go higher for some feature that looks really useful. As far as I can tell, all of these should do what they claim, and you are simply looking at issues of pricing, convenience, ionic vs. colloidal, etc. Ionic machines will either say they are ionic, or indicate that they use a "current limiting" circuit.

Regarding costs, keep in mind that you may have friends who would be willing to split the cost with you. Many people would be pleased to have a nearby source of virtually free colloidal silver solution whenever they needed some. It's pretty easy to create a co-op with something like this.

I have to say I'm impressed with this one. \$95 (U.S. version) buys a lot of convenience, a nice design, and the option of choosing particle size by adjusting the amount of current. It's also manufactured by a company with a good history and reputation, Scada Research.

The unit I built myself still works perfectly, but eventually my curiosity about adjustable current control got the better of me. I bought this one and have been quite happy with it. I see the current price is \$120 which is quite reasonable.

scadaresearch.com



[WEBPAGE](#)

At \$99 this unit claims to shut itself off when you have achieved a desired strength, which you set on a dial that goes from one to ten. This would eliminate a lot of guesswork.

This model has been redesigned. Still called the Colloid Master AC, it uses a mystery method to stir the solution while it runs. Price is now \$140 at wishesgranted.com.

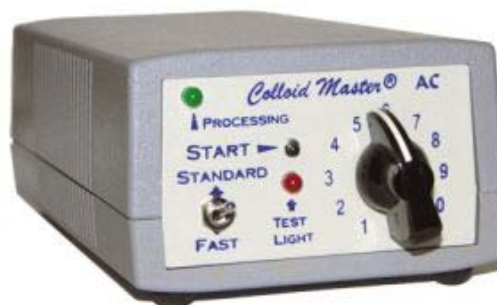

WEBPAGE

Here's an unusual design at \$125 that produces the ionic form of silver particles—because the solution remains clear from the start. I find it interesting mostly because someone has put a lot of thought into what they wanted to achieve; and a lot of work into creating a product to match. Notice the laser beam used to demonstrate the presence of CS.

This is still around, though naturally more expensive. There is an optional magnetic stirrer which should help ions avoid packing together to become colloids.

Find at: Silverpuppy.com



WEBPAGE

Here's the classic battery-and-wires design, but with an upgrade. A current limiting circuit in the battery cap keeps the process under control, no doubt creating a cleaner looking C.S. Since it takes up to two hours to make quart of solution, I assume that the combination of low voltage and low current is producing plenty of ions in the mix.

Perfect for the backpack. Sells for \$49.

Note the insulated alligator clips used to connect to the silver.

Unfortunately the original source for this one seems to be gone. I'm rather hoping to run across it somewhere else.

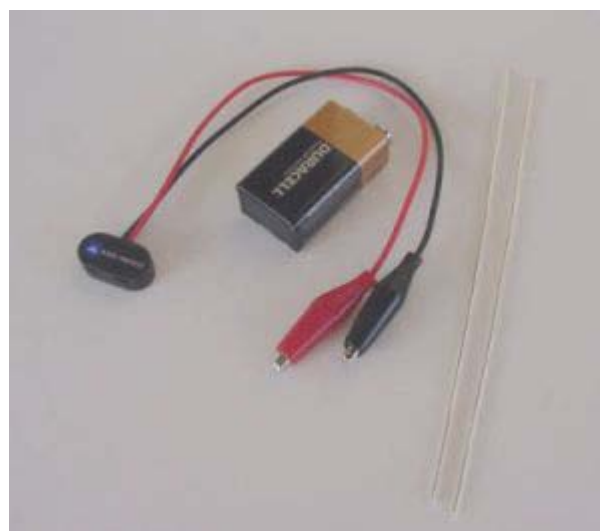

This is by far the most clever design for a CS unit that I've ever run across. It is from T.J. Wiggins, who was once known as Johnny Silverseed for his work in spreading the word about making your own CS. These little guys get their power by simply plugging into a telephone jack! Looks like you can make a good-sized dose of CS in about a minute and half. You can get two of them for \$14. (You may want to pick up a telephone extension cord!)

You can even get one for free if you order a copy of T.J.'s 1999 book, *Colloidal Silver: Antibiotic Superhero*, for \$16.50.

For economy, \$42 is hard to beat. These are made by a veteran campaigner for classic colloidal silver, T.J. Wiggins in Arizona. They are very straightforward; simply a power supply that plugs into the wall, with silver wires attached to a connector at the other end of the cord.

T.J. is "old school" and advocates gathering up all the loose silver ions and persuading them to clump together until they reach the larger colloidal size range. His secret for doing this is to add a very tiny amount of pure Vitamin C to the freshly made solution.

Originally carrying the name Elixsilver, these products are now at Colloidalsilver101.com.

The site is confusing, but it appears the Economy model has been improved, yet still retails for \$50. An upgraded unit produces CS in half the time for \$87.



WEBPAGE